

Shengmilo

Owner's Manual



About Manual

This manual contains many Warnings and Cautions concerning safe operation, and consequences if proper setup, operation and maintenance guidelines are not followed. All information in this manual should be carefully reviewed.

WELCOME TO SHENGMILLO

- This manual contains details of the product, information on its operation and maintenance, and other helpful tips for owners. Read it carefully and familiarize yourself with the Shengmilo S900 before using it to ensure safe use, reduce the risk of damage and premature wear, and prevent accidents. Be sure to retain this manual as your convenient Shengmilo S900 information source.



The safety grade color of Caution is orange, and if not avoided, may result in moderate or serious injury.



The safety grade color of Warning is red, and if not avoided will likely result in serious injury or death



ATTENTION

- Because it is impossible to anticipate every situation or condition which can occur while riding, this manual makes no representations about the safe use of our bicycles under all conditions. There are risks associated with the use of any bicycle which cannot be predicted or avoided, and which are the sole responsibility of the rider. You should keep this manual, along with any other documents that were included with your bicycle, for future reference, however all content in this manual is subject to change or withdrawal without notice.
- Visit www.shengmilo-bikes.com to download the latest version. Assembly and first adjustment of your Shengmilo S900 require special tools and skills, and it is recommended that this be performed by a trained bicycle mechanic if possible.

01 BIKE SPECIFICATION



BIKE SPECICATION



BIKE SPECICATION

PARAMETER

**Weight**

48 kg

**Frame**

Aluminium alloy

**Meter**

Color LCD Display

**Brake**

Hydraulic Oil Brake

**Damping**

Shock absorption

**Battery**

60V30AH

**Assistance mileage**

80-100KM

**Tyre**

20X4.0

**Pure electric range**

60-70KM

**Charging time**

8-10H

**Engine**

1500W Motor

**Controller**

Intelligent Brushless Controller

**Torque**

150N·M

**Transfer**

Level 7 Shimano

**Gradability**

45 °

**Speed**

Up to 65KM/H

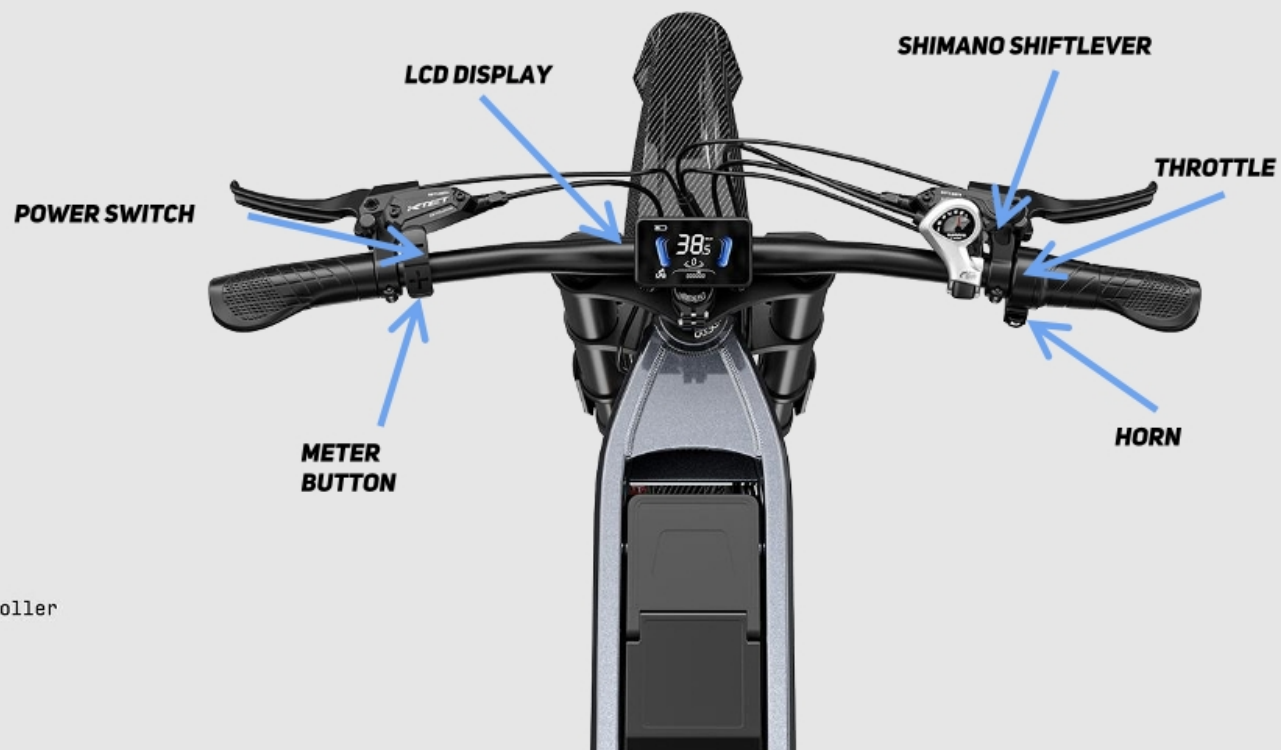

BIKE SPECICATION

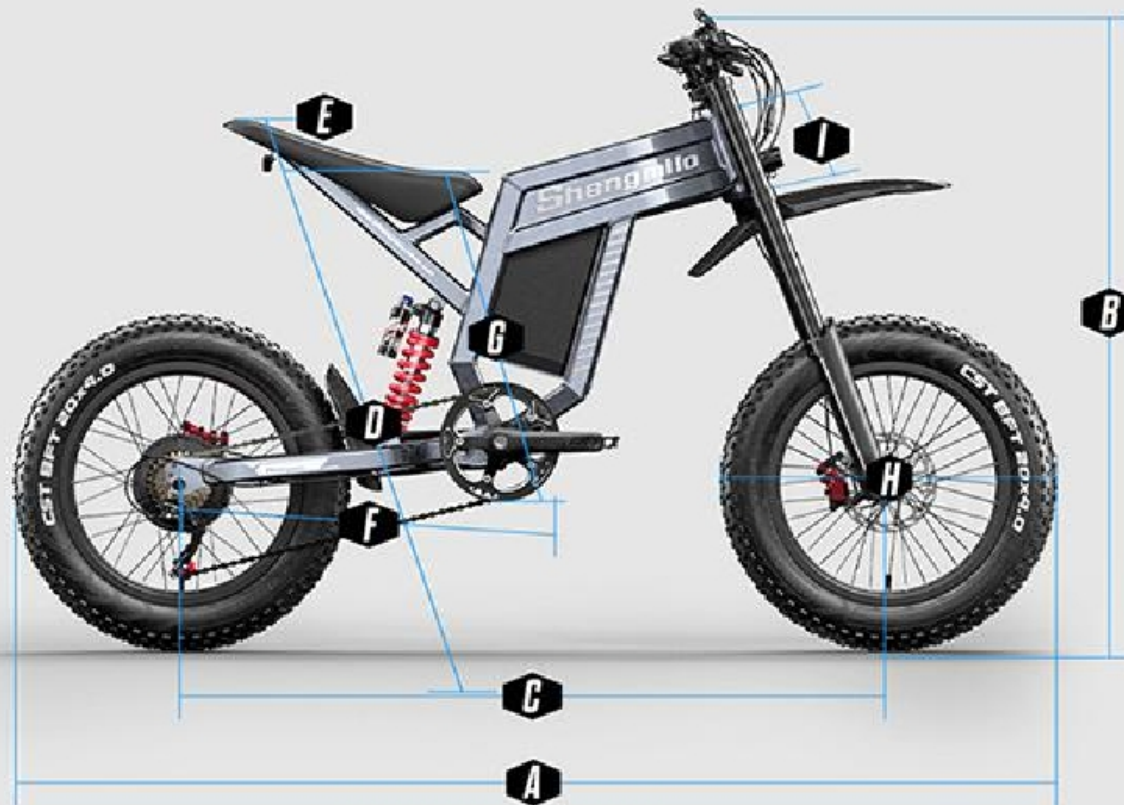

- A** Total Length: 185cm
- B** Handlebar Height: 105cm
- C** Wheelbase: 122cm
- D** Minimum Seat Height: 82cm
- E** Maximum Seat Height : 90cm
- F** Chain Stay Length : 54cm
- G** Standover Height: 50cm
- H** Wheel Diameter: 50cm
- I** Head Tube Length : 16cm
- J** THandlebar Length: 77cm

BIKE SPECIFICATION

Battery	60V 30Ah SAMSUNG Cells	Charger	EU plus 2.0 A smart charger
Range	PAS mode: 90–100KM; Trottle mode : 60~70 KM	Controller	Sine wave brushless motor controller
Motor	1×1500W (rear wheel)	Display	Yolin color display
Total Payload Capacity	400 lbs (180kg)	Weight	99.2 lb (45KG)
Recommended Rider Heights	5'5" ~ 6'6" (165–200cm)	Pedal Assist Intelligent	0~5 Level pedal assist
Tires	20" x 4.0 Non-slip fat tires	Throttle	Half twist throttle
Brake	Dual hydraulic oil brakes	Front Fork	Double shoulder fork shock absorber
Horn	The horn is integrated in the headlight	Pedal	Wellgo alloy pedals with reflectors
Freewheel	Shimano 7-speed gear shift system	Bike Frame	6061 Aluminum frame
Brake	Disc brakes	Headlight	Super bright LED light
Chain	KMC chain	Saddle	Thick and comfortable leather seat
Stem	Promax MA-400 SSABK	Seatpost	Diameter 30.4mm length 350mm
Crankset	170mm forged alloy	Kickstand	Heavy-duty aluminum
Gearing	Shimano, TX55/7 speed rear puller	Spokes	Front wheel 13G*218/Rear wheel 13G*218

02 BIKE Assembly Guide



Hardware Location	Recommended Torque(NM)
Handlebar	12-18
Stem	12-18
Saddle	12-18
Front Wheel(For bikes with bolts on front wheel)	15-22
Rear wheel	30-38
Bottom Bracket Parts	30-50
Pedals	28-33
Disk Mounting Bolts	3-5
Disk Caliper Mount	6-8
Crank Bolts	32-36
Rear Derailleur Cable Pinch	3-5
Front Derailleur Clamp	3-6
Saddle Post Clamp	3-6

NOTICE: Using an impact driver to achieve the required torque is not recommended as it might cause damage. We suggest you use the wrench set we provided and extra tools to manually adjust nuts and bolts

PARK:1 REMOVE PACKAGING

Prompt:

Please read the installation steps before installation, and install according to the installation pictures and texts

 Please go to our YouTube channel "Shengmilo official store" to watch our assembly.



01

Unpack the Shengmilo electric bicycle, take out the electric bicycle and accessories



02

Check the completeness of the accessories and prepare the assembly tools.

Assembly Guide

PARK:2 INSTALL SHOCK ABSORBERS

NOTICE: Before assembling your bike, it's recommended to remove the battery for the reasons outlined below:

1. Determine if there's battery drain or damage during shipping.
2. Reduce the weight of the e-bike to make it easier to maneuver the bike while assembling.
3. Avoid battery damage during the assembly process.

**01**

Use tools to remove the fixing device

**02**

Install the shock absorber here

**03**

Prepare the parts to assemble the shock absorber

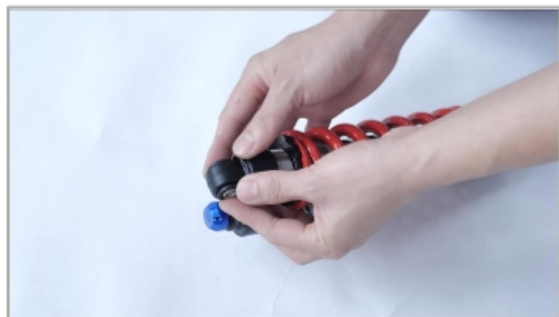
**04**

Install the shock absorber accessories as shown in the figure

**04**

Place the shock absorber on the frame and fix it with screws

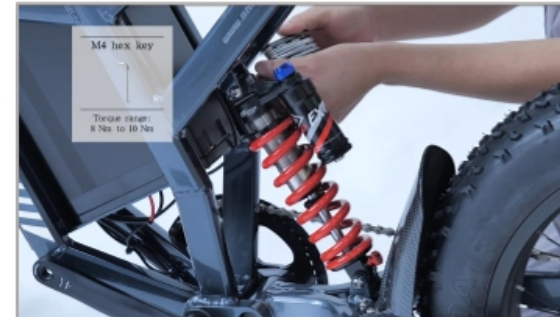
**04**

Tighten the screws with tools

PARK:3 HANDLEBAR INSTALLATION

NOTICE: Before tightening the bolts on the valve stem, pay attention to adjusting the angle and balancing the left and right handles.

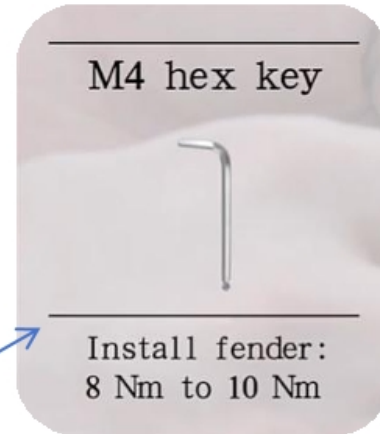

01

Loosen the bolts on your bike stem



02

Center your handlebars and rotate them to align to the marking pointed to in the below image



03

Tighten the bolts to the handlebar stem, adjust the angle for more precise alignment, and fully tighten all bolts on the stem after determining the optimal position.

Assembly Guide

PARK:4 FRONT WHEEL INSTALLATION

NOTICE: Make sure the brake rotor is aligned with the brake caliper, so the brake rotor can easily enter the caliper without any friction.

**01**

Use tools to remove the quick release skewer

**02**

Place the tire in the corresponding position, thread the quick release skewer through the center, and tighten the screw.

PARK:5 INSTALL FENDER

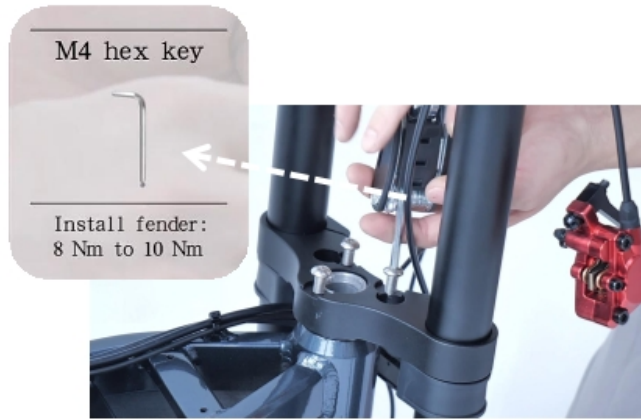

01
Use tools remove the screws



02
Prepare the fender and screws.



03
Align the screws with the holes and tighten them with tools.

Assembly Guide

PARK:6 INSTALL BRAKE ASSEMBY

NOTICE: Before assembling your bike, it's recommended to remove the battery for the reasons outlined below:

1. Determine if there's battery drain or damage during shipping.
2. Reduce the weight of the e-bike to make it easier to maneuver the bike while assembling.
3. Avoid battery damage during the assembly process.

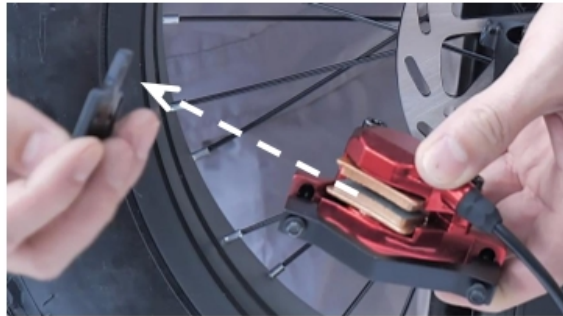

01
Remove the washer



02
Remove the screw washer as well.



03
Align the screw with the hole

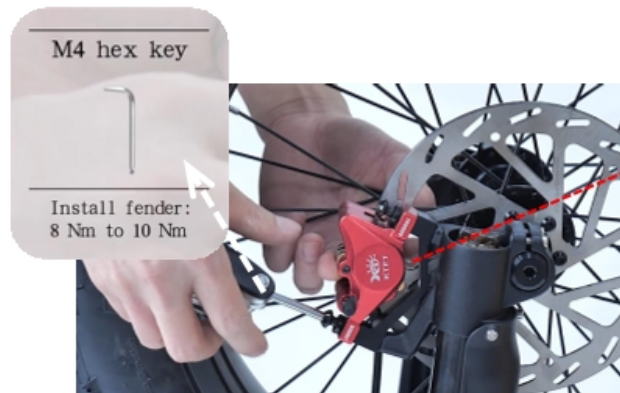

04
Tighten the screw



05
While tightening the screws, check the brake performance

PARK:7 PEDAL INSTALLATION

NOTICE: Make sure your pedals are installed on the correct side, as installing on the wrong side will damage the threads. Indicators for the right pedal (R) and the left pedal (L) can be found in two places: the stickers on the plastic cover, and the bottom of the pedal threads.

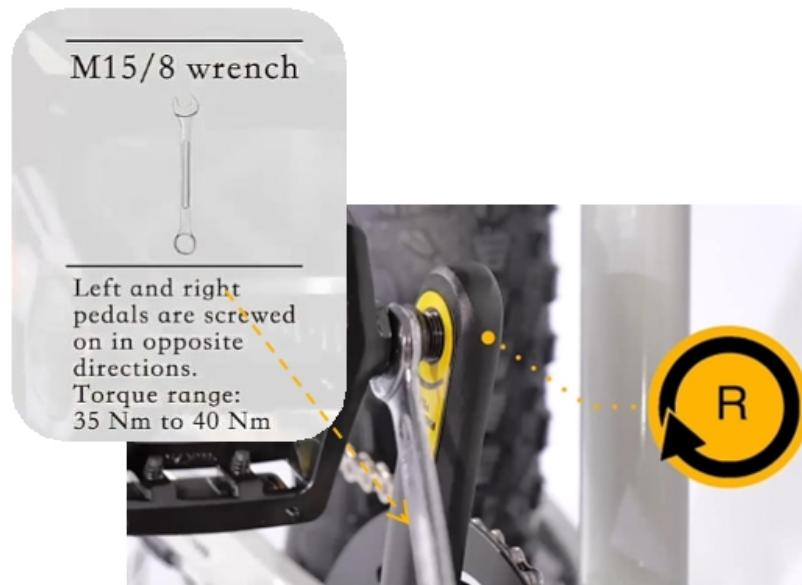

01 Right pedal

Use a wrench to tighten clockwise



01 Left pedal

Use a wrench to tighten counterclockwise.

Before you install the pedals, apply a small amount of waterproof grease onto the spindle. Start threading the pedal on by hand to ensure the pedal is going in perfectly straight, rotating in the direction of the pointer shown on the crank. If it is not spinning smoothly, make doubly sure that you have the correct left or right pedal. After initial hand-tightening, finish tightening the pedals with a standard 15mm wrench

Assembly Guide

PARK:8 TIRE AND START - UP INSPECTION

**01**

Use an air pump to inflate the tire

**02**

Lock the battery

**02**

Start and operate

**02**

Check the operation status

PARK:9 CHARGE INSPECTION

Charging Tips

- The battery can be recharged on or off the bike.
- A new battery may take longer to be fully charged when depleted.
- The charger will automatically stop charging once the battery pack is fully charged.
- You can recharge the battery after short rides as it does not have a memory effect.



01

When the power indicator is green, it means the device is in standby for charging



02

When the power indicator is red, it means it is charging



02

You can also remove the battery for charging

◆After Charging

1. Please unplug the main power supply first by removing the plug from the power socket, then remove the DC port from the battery. You can then check the battery status on the display screen.
2. Insert the battery with caution, making sure that the slots at the bottom of the battery align with the pins on the bike frame, and slide in carefully to avoid damaging the interior circuitry.
3. Lock the battery when finished to prevent theft.

◆NOTICE

If your battery displays abnormal charging behavior, such as:

1. Longer-than-expected charge time
 2. Strange smell, smoke, or liquid emanating from battery and/or charger
 3. Overheating battery and/or charger
- Please stop charging and contact www.shengmilo-bikes.com immediately.

03 SAFETY CHECKLIST

Safety Check	Basic Steps
Brakes	<ul style="list-style-type: none"> o Test front and rear brakes for proper function. o Ensure brake pads are not overworn and are correctly positioned in relation to rims. o Make sure brake control cables are lubricated, correctly adjusted and display no obvious wear. o Check that brake control levers are lubricated and tightly secured to handlebars.
Wheels and Tires	<ul style="list-style-type: none"> o Inflate tires to within recommended limits displayed on sidewalls. o Check for bulges or signs of excessive wear. o Clean tires to ensure tread is exposed. o Ensure rims run true and have no obvious wobbles or kinks. o Check that all wheel spokes are tight and not broken. o Check the wheel balance in Pedal Only Mode. If you notice the riding is imbalanced or the rotation of the front wheel makes noise, it means the bolts were not completely tightened or not aligned horizontally.
Chain	<ul style="list-style-type: none"> o Check that chain is oiled, clean and runs smoothly. o Use extra care in wet or dusty conditions.
Crank and Pedals	<ul style="list-style-type: none"> o Securely tighten pedals to cranks. o Ensure cranks are securely tightened and are not bent.
Derailleurs	<ul style="list-style-type: none"> o Check that derailleu(s) are adjusted and functioning properly. o Ensure shift and brake levers are attached to handlebar securely. o Check all brake and shift cables for proper lubrication..
Motor Drive	<ul style="list-style-type: none"> o Ensure hub motor is spinning smoothly and motor bearings are in good working order. o Check that all power cables running to hub motor are secured and undamaged. o Make sure hub motor axle bolts are secured and all torque arms and torque washers are in place.
Battery Pack	<ul style="list-style-type: none"> o Ensure battery is charged before use. o Check for any visible damage to battery pack. o Lock battery securely to frame.



04 Shengmilo E-Bike Use and Care



Use and Care

PARK:1 BASIC DISPLAY SETTINGS**◆CONTROL PANEL**

The following table of contents provides general guidance on Shengmilo e-bike variable power assist settings and their effects on both range and performance. This content will apply broadly to most riders, but multiple factors will affect individual results including rider fitness and weight, terrain, proper maintenance, etc. While Shengmilo hopes and believes you will thoroughly enjoy your e-bike, no guarantees of universal performance characteristics for all owners can be given.

PARK:1 BASIC DISPLAY SETTINGS

◆LCD METER FUNCTIONAL AREA DISTRIBUTION



Figure 4-1 YL81F-H functional area distribution interface

PARK:1 BASIC DISPLAY SETTINGS

◆LCD METER KEY GUIDE

Key operations include short press, long press, and long press key combinations. Details are as follows:

1. Long press the  key to power on/off the E-bike

*If the electric bike is not used for more than 10 minutes, the LCD meter will automatically shutdown

2. After power on, the LCD meter displays real-time speed (km/h) and total mileage (DOD) by default. Short press the  key to display the information to switch between total mileage (DOD), single mileage (TRIP), maximum speed(MAX), and average speed(AVG).

3. Short press the  key or the  key to switch the power level (PAS). The proportional output is shown in the following table:

PAS	1	2	3	4	5
Output	0%	50%	73%	85%	96%



4. Press the  button to turn on the headlights, Pressing off again, the LCD instrument backlight dims when the headlights are turned on, and returns to brightness when the headlights are turned off.

5. Press and hold the  button, and the electric bicycle enters the electric assist push mode.

Electric bikes will travel at an average speed of 6 kilometers per hour. At the same time, the screen displays .

Press and hold the  key again or press the brake to cancel this mode.

*The push function is recommended to be used when pushing the bike uphill. Do not use this function while riding.

6. Cruise mode: When using pure electric power, reach the speed you are satisfied with, long press the  button to enter the battery life mode. Press and hold the  key again or press the brake to cancel this mode.

*It is recommended to use this mode when the road surface is flat and there are few people.

7. When the electric control system of the electric bicycle fails the instrument will automatically display the error code.

The detailed error code definition is shown in the following table:

E001	Controller Malfunction	E004	Turning Handle Failure
E002	Circuit Malfunction	E005	Brake Lever Fault
E003	Hall Fault	E006	Motor Phase Loss



When there is an error code on the display page, please contact the dealer in time to help you troubleshoot, the electric bicycle will not be able to run normally when there is a fault.

PARK:2 PARAMETER SETTING

◆PERSONALIZED PARAMETER SETTING STEPS

Note: In the power-on state, the operation is performed when the display speed of the instrument is 0.

Press and hold the **+** **-** button for more than 2 seconds at the same time to enter the personalized parameter setting item selection interface

Short press the **+** **-** key to switch the selection interface of the personalized parameter setting item, short press the **i** key to enter the state of changing parameters

Short press **+** **-** key to select parameters, long press **+** for continuous addition operation, long press **-** for continuous reduction operation

Short press the **i** key to save the parameter settings and return to the personalized parameter setting item selection interface

Press and hold the **i** key to save the parameter settings and exit the personalized parameter setting option interface.

PARK:2 PARAMETER SETTING

Display interface switching

When the display is powered on, it will show the Current Speed (km/h) and Trip Odometer (km) by default. Short press **i** to switched cyclically between Trip Odometer (km), Odometer (km), Maximum Speed (km/h), and Average Speed (km/h).

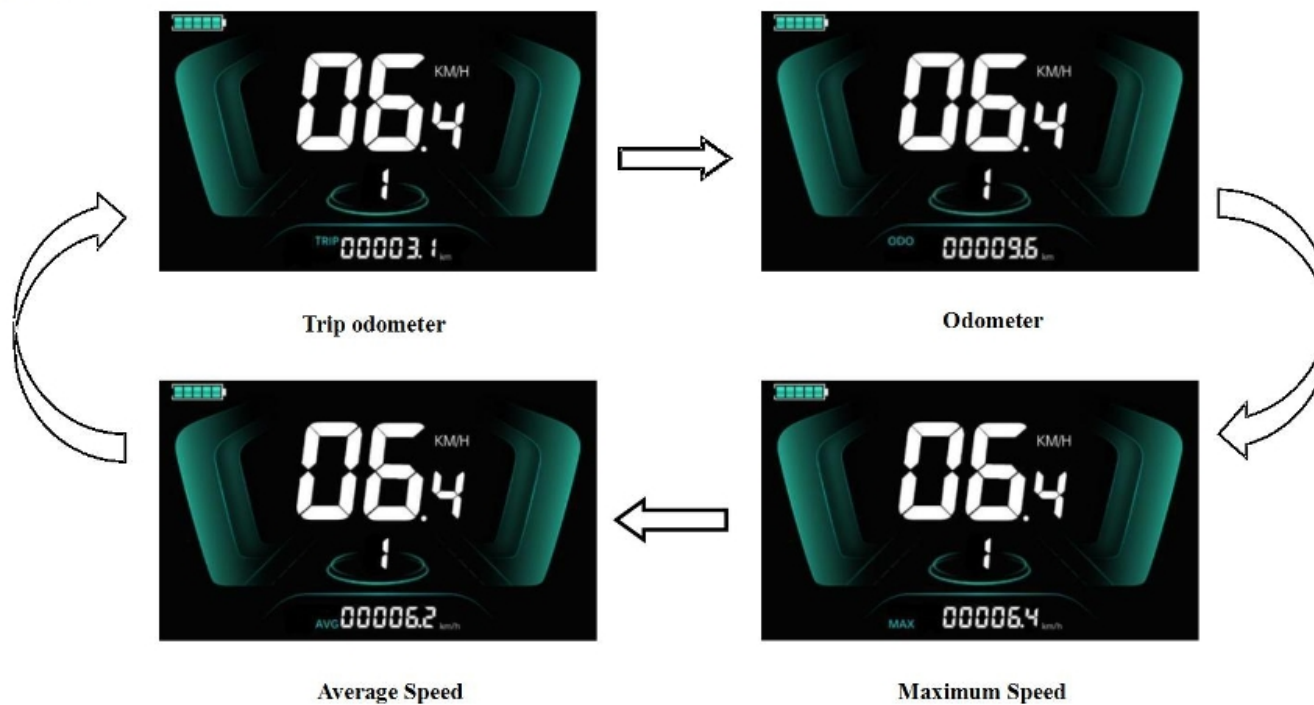

Figure 5-1 Display interface switching interface

Walk boost mode



Long press and hold , the electric bicycle enters the walk boost mode. The electric bicycles will travel at walking speed and the display shows . Release the button to stop the power output immediately and restore to the state before walk boost.



Figure 5-2 Walk boost mode display interface

⚠ The walk boost mode can only be used when pushing the electric bicycle, please do not use it while riding.





Press the  to make the controller turn on the lights and the display backlight becomes dim. Press  again to make the controller turn off the lights and the backlight restore brightness.



Figure 5-3 Backlight display interface

PAS level selection

Press  /  to switch PAS level of electric bicycle, thus changing the motor output power. (The following pictures are only for illustration of different speeds in different gears. The specific speed is subject to the actual product)

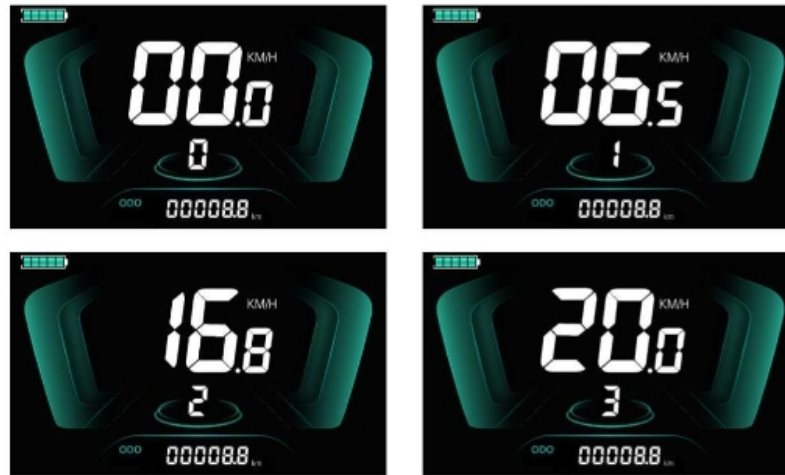

Figure 5-4 PAS level display interface

Battery level display

The Battery level is shown as 5 bars. When the battery is full charged, all of the 5 bars lighten up. When the battery is fully depleted, the bar begin to flash, warning the user to charge the battery as soon as possible.

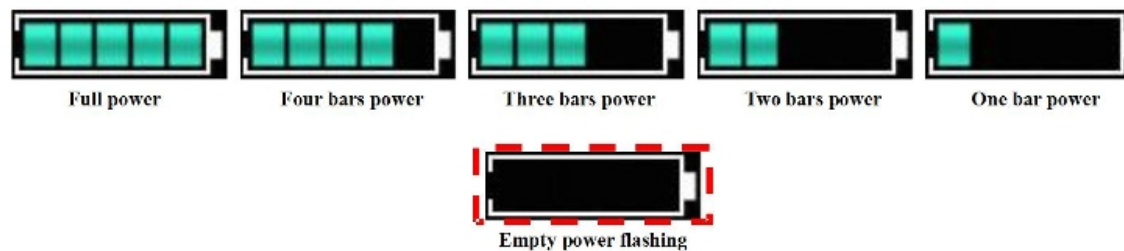

Figure 5-5 Battery level display interface

Error code display

If there is a fault occurs in the electronic system of the electric bicycle, the display will automatically show an error Code, see **Schedule 1** for a detailed definition of the error code.



Figure 5-6 Error code display

Personalized parameter settings

⚠ Each setting needs to be done with the bicycle stationary.

The personalized parameter setting procedure is as follows

When the display is ON and the speed shows 0,

- (1) Press and hold **+** **-** simultaneously for more than 2 seconds to enter the personalized parameter setting interface.
- (2) Press **+** / **-** to toggle between the personalized parameter setting interface, and press **i** to enter the parameter changing state.
- (3) Press **+** / **-** to select the parameter. Long press **+** for addition operation, long press **-** for subtraction operation.
- (4) Press **i** to save the parameter settings and return to the personalized parameter setting interface.
- (5) Long press **i** to save the parameter setting and exit the personalized parameter setting interface.

The following options are available on the personalized parameter setting interface:

Backlight luminance setting

01P refers to the backlight luminance setting option, The adjustable range is : 1~3, 01 for the minimum luminance, 02 for the standard luminance, 03 for the maximum luminance.

Press **i** to enter the parameter changing state. Press the **+**/**-** to select the parameter and press **i** to save the parameter setting and return to the personalized parameter setting interface.

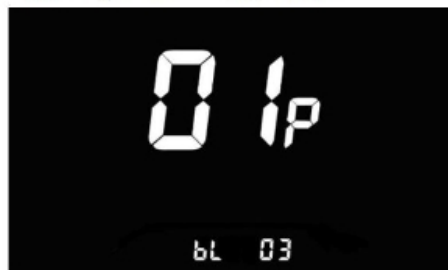

Figure 6-1 Backlight luminance setting interface

Metric and Imperial setting

02P is the metric and imperial setting option, 00 for metric and 01 for imperial.

Press **i** to enter the parameter changing state. Press the **+**/**-** to select the parameter and press **i** to save the parameter setting and return to the personalized parameter setting interface.



Figure 6-2 Metric and Imperial setting interface

Rated voltage setting

03P is the rated voltage setting option. The available rated voltage range is : 36V, 48V, 52V, 60V.

Press **i** to enter the parameter changing state. Press the **+**/**-** to select the parameter and press **i** to save the parameter setting and return to the personalized parameter setting interface.

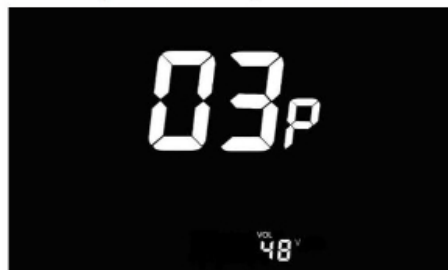

Figure 6-3 Rated voltage setting interface

Auto sleep time setting

04P is the auto sleep time setting option. To save the battery power and reach higher range, this display will be turned off after it has not been used for a time. The adjustable range is : 00~60min, 00 means no auto shutdown. The factory default setting is 10 minutes.

Press **i** to enter the parameter changing state. Press the **+**/**-** to select the parameter and press **i** to save the parameter setting and return to the personalized parameter setting interface.



Figure 6-4 Auto sleep time setting interface

PAS level setting

05P is the PAS level setting option. The available Pedal assist level setting are: 0~3, 1~3, 0~5, 1~5.

Press **i** to enter the parameter changing state. Press the **+**/**-** to select the parameter and press **i** to save the parameter setting and return to the personalized parameter setting interface.



Figure 6-5 PAS level setting interface

Wheel diameter setting

06P is the wheel diameter setting option. The adjustable wheel diameter range is : 8~32inch.

Press **i** to enter the parameter changing state. Press the **+**/**-** to select the parameter and press **i** to save the parameter setting and return to the personalized parameter setting interface.



Figure 6-6 Wheel diameter setting interface

Number of speed sensor magnets setting

07P is the speed sensor magnet number setting option. The adjustable speed sensor magnet number range is : 1~255pcs.

Press **i** to enter the parameter changing state. Press the **+** / **-** to select the parameter and press **i** to save the parameter setting and return to the personalized parameter setting interface.



Figure 6-7 Number of speed sensor magnets setting Interface

Speed limit setting

08P is the speed limit setting. The adjustable speed limit range is: 1~100km/h. (The maximum adjustable speed limit varies by different protocols).

Press **i** to enter the parameter changing state. Press the **+** / **-** to select the parameter and press **i** to save the parameter setting and return to the personalized parameter setting interface.



Figure 6-8 Speed limit setting Interface

Start-up setting

09P is the start-up setting option. The display can choose the following start modes: 00→zero start, 01→non-zero start.

Press **i** to enter the parameter changing state. Press the **+** / **-** to select the parameter and press **i** to save the parameter setting and return to the personalized parameter setting interface.



Figure 6-9 Start-up setting interface

Drive mode setting

10P is the drive mode setting option. The available drive modes are: 00→Pedal assist only, 01→Electric only, 02→Both Pedal assist and electric.

Press **i** to enter the parameter changing state. Press the **+** / **-** to select the parameter and press **i** to save the parameter setting and return to the personalized parameter setting interface.



Figure 6-10 Drive mode setting interface

Pedal assist sensitivity setting

11P is the Pedal assist sensitivity setting option. When set to higher number, it will take more crank rotations to activate the motor. On lower numbers, it will take little crank rotation to activate the motor. The adjustable range is :1~24.

Press **i** to enter the parameter changing state. Press the **+** / **-** to select the parameter and press **i** to save the parameter setting and return to the personalized parameter setting interface.



Figure 6-11 Pedal assist sensitivity setting interface

Pedal assist strength setting

12P is the Pedal assist strength setting option. The Pedal assist strength is the relative strength of the PWM signal from the controller when start to activate pedal assist. The adjustable range is : 0~5. 0 is the weakest strength and 5 is the strongest.

Press **i** to enter the parameter changing state. Press the **+** / **-** to select the parameter and press **i** to save the parameter setting and return to the personalized parameter setting interface.



Figure 6-12 Pedal assist strength setting interface

Number of pedal assist sensor magnets setting

13P is the number of pedal assist sensor magnets setting option. The adjustable range is: 5~12 pcs.

Press **i** to enter the parameter changing state. Press the **+**/**-** to select the parameter and press **i** to save the parameter setting and return to the personalized parameter setting interface.



Figure 6-13 Number of pedal assist sensor magnets setting interface

Controller current limit setting

14P is the controller current limit setting option. The adjustable range is : 1~50A.

Press **i** to enter the parameter changing state. Press the **+**/**-** to select the parameter and press **i** to save the parameter setting and return to the personalized parameter setting interface.



Figure 6-14 Controller current limit setting interface

Battery under voltage value setting

15P is the battery under voltage setting option. The value can be adjusted based on the current rated voltage.

Press **i** to enter the parameter changing state. Press the **+**/**-** to select the parameter and press **i** to save the parameter setting and return to the personalized parameter setting interface.

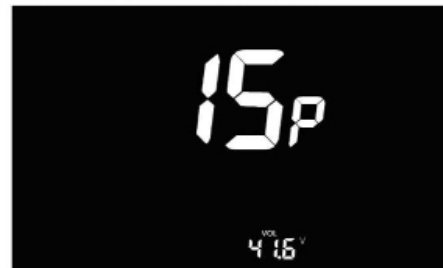

Figure 6-15 Battery under voltage value setting interface

ODO reset setting

16P is the ODO reset setting option. The adjustable range is : 00 represents the ODO not reset, 01 represents the ODO of reset.

Press **i** to enter the parameter changing state. Press the **+**/**-** to select the parameter and press **i** to save the parameter setting and return to the personalized parameter setting interface.



Figure 6-16 ODO reset setting interface

Controller automatic cruise setting

17P is the controller automatic cruise setting option. 00 means disable cruise, 01 means enable cruise.

Press **i** to enter the parameter changing state. Press the **+**/**-** to select the parameter and press **i** to save the parameter setting and return to the personalized parameter setting interface.



Figure 6-17 Controller automatic cruise setting interface

6km/h walk boost setting

18P is the 6km/h walk boost setting. The display can choose the following: 00→turn off walk boost function, 01→turn on walk boost function.

Press **i** to enter the parameter changing state. Press the **+**/**-** to select the parameter and press **i** to save the parameter setting and return to the personalized parameter setting interface.



Figure 6-18 6km/h walk boost setting interface

Shortcut operation

Restore factory default parameter settings operation

dEF is the restore factory default parameter settings. dEF-Y is the restore the factory default settings, and dEF-N is not to restore.







Enter into the main setting interface and keep the speed at 0, press and hold  and  simultaneously for 2s to enter the restore factory default setting interface. Pressing  /  to toggle to dEF-Y. Then after pressing  to confirm, the display will show dEF-0 for a few seconds and then automatically start to restore the default settings. The display will automatically exit to setting interface after the restoration.



Figure 7-1 Restore factory default parameter setting interface

Trip odometer reset operation

The display can record trip odometer and odometer. Trip odometer is not automatically reset after turning off. The trip odometer needs to be reset manually. The odometer can not be reset.

Enter into the main setting interface and keep the speed at 0, press and hold  and  simultaneously for 2s to reset the trip odometer. The main interface will flash during the reset process.

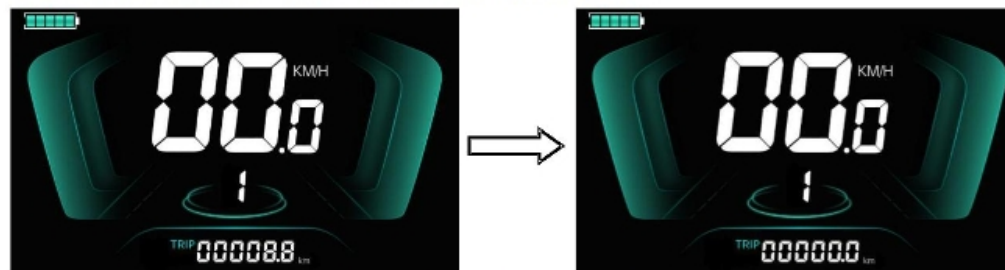

Figure 7-2 Trip odometer reset interface

05

PRECAUTIONS AND MAINTENANCE



PARK:1 BATTERY

◆ Before Riding

Ensure that the battery has been properly secured to the bike before each use by grasping the battery pack and pulling upwards, testing the security of the pack.

◆ Battery Maintenance (60V 30AH Shengmilo Lithium battery)

- Do not fully drain your battery. Turn off the power when the battery charge is low.
- Fully charge the battery after each use, no matter how much power is used. This will prolong the battery life. If battery power is not used for a long time, store the battery with a full charge and charge it once a month.
- The Shengmilo bike can be safely ridden in light rain. However, riding through very heavy downpours or through flooded streets is not recommended, as the crank and/or motor can get wet, which may cause damage.
- Keep the battery away from open flame and other high-temperature heat sources. Do not expose the battery to direct sunlight or recharge immediately after use in high-temperature weather.

NOTICE: It is not recommended to make any modifications to the battery or the motor. If the battery is tampered with, and there are any problems with the altered battery or motor, it will not be covered under Shengmilo's warranty.

PRECAUTIONS AND MAINTENANCE

PARK:2 CHARGER CARE INFORMATION

1. Check the charger, charger cables, and battery for damage before beginning each charge.
2. Always charge in a safe area that is cool, dry, indoors, away from direct sunlight, dirt, or debris, in a clear area away from potential to trip on the charging cords, or for damage to occur to the bike, battery, or charging equipment while parked and/or charging.
The battery can be charged on or off the bike.
3. The battery should be recharged after each use, so it is ready to go the full range per charge next ride. There is no memory effect, so charging the battery after short rides will not cause damage.
4. Charging the battery normally takes 6–7 hours.
5. The charge indicator lights will show a red light while the battery charges. When charging is complete, one indicator light will turn green. Ensure the lights face upward when charging.
6. Remove the charger from the battery within one hour of the green light indicating a complete charge.
7. Never charge a battery for more than 12 hours at a time. Do not leave a charging battery unattended.

PRECAUTIONS AND MAINTENANCE

PARK:3 RIDING MODES

◆ Pedal-assist

Pedal-Assist is an operating mode on e-bikes designed to engage the motor to assist, but not replace, your own pedaling effort. When you are operating your bike in the pedal-assist mode, you can adjust the setting according to your preference. Shengmilo has five pedal assist settings – ranging from 1 to 5.

- Higher pedal settings (L4/5) would be most helpful for those who want to ride faster with minimum effort. These settings are perfect for people who want to arrive fresh and timely at work, without being sweaty and exhausted.
- Lower pedal settings (L1/2) are popular for Shengmilo riders to use after work, or when leisurely exercise is preferred. These are best to use on the way home from work, to refresh yourself and relieve stress accumulated throughout the entire workday. Moreover, lower settings can extend the usable range for longer rides, maximizing enjoyment while minimizing physical stress and fatigue.

◆ Throttle-only

The throttle mode is similar to how a motorcycle or scooter operates, alleviating the need to pedal or providing an additional boost simply by twisting the throttle.

Shengmilo S900 can reach speeds of up to 25 miles per hour with throttle mode, which not only allows you to travel faster but also reassures riders with extra power whenever needed, depending on traffic conditions and rider energy levels. If you are an adventurer who chases after speed and distance without compromising comfort or safety, the throttle-assisted Shengmilo would be your perfect companion.

◆ Pedal-only

In this mode, the Shengmilo will perform like a normal bike, as you'll be riding without any assistance from the motor. This mode is especially useful if you run out of battery, or are looking for more intensive resistance training.

We suggest that you select a lower assistance level when you first ride your Shengmilo S600. After becoming more comfortable with the riding characteristics of our e-bike, and more familiar with the varying range requirements of your most common destinations and commuting routes, you can then make any needed adjustments to pedal-assist settings, as well as the throttle use frequency, riding position, etc.

◆ Riding Limitations

Following are some limitations needing riders' careful attention to ensure the hub motor does not overheat or become damaged from excessive loading:

- Do not attempt to ride up hills steeper than 15% grade.
- Use the pedals to assist the motor when climbing hills and accelerating from a stop.
- Avoid sudden starts and stops.
- Generally accelerate at a moderate pace, rather than aggressively

PRECAUTIONS AND MAINTENANCE

PARK:4 MAINTENANCE

◆ Battery Maintenance (60V 30AH Shengmilo battery)

1. Don't fully drain your battery. Turn off the power when the battery charge is low.
2. Fully charge the battery after each use, no matter how much power is used. This will prolong the battery life. If the battery is not used for a long time, store the battery with a full charge and charge it once a month.
3. Shengmilo S900 can be safely ridden in light rain. However, riding through very heavy downpours or through flooded streets is not recommended, as the crank and/or motor can get wet, which may cause problems.
4. Keep the battery away from an open flame or a high-temperature heat source. Do not expose the battery to direct sunlight or recharge immediately after use in high-temperature weather.

◆ Motor Maintenance (1500W Geared Hub Motor with 160 Nm of torque)

1. Please check your motor frequently and tighten any loose screws or nuts, to prevent the bike from breaking down due to disconnected wires.
2. The brushless motors are not waterproof, so avoid riding through water deeper than the lower edge of the electric wheel hub to avoid motor failure.

◆ Chain Maintenance

1. We recommend cleaning the chain after each ride, especially in rainy and humid environments. Use a dry cloth to wipe the chain and its accessories clean. Use a brush to remove sand and dirt stuck in the chain, along with use warm soapy water if needed. Do not use strong acidic or alkaline cleaning agents (such as rust remover), because these chemicals can damage the chain.
2. Apply lubricating oil after cleaning to avoid rust. First, make sure the chain is dry, and then apply the lubricating oil to the bearings.
3. To prevent unnecessary chain wear, try to maintain a vertical chain position when shifting gears (do not use the smallest gear with the smallest flywheel, or the largest gear with the largest flywheel, etc.).

◆ Front Fork Maintenance

1. Always use a clean, oil-free lint-free cloth with plain or soapy water to clean your bike. To prevent water from flowing into the front fork, you can turn the bike upside down. Dry with a lint-free towel after washing. Pay specific attention to the inner tube and the dust seal to reduce wear and prevent thinning of the inner tube, which can lead to significant damage if the aluminum is exposed to air.
2. We recommend using a front fork dust cover to protect the inner tube of your front fork. This prevents dust from entering as well as hard objects from hitting the inner tube.

PRECAUTIONS AND MAINTENANCE

PARK:5 LIMITED WARRANTY

Warranty Info

•All Shengmilo e-bikes are covered under our manufacturer's 1 year, 6 months, and three months warranty for the original owner against all manufacturing defects (All free Accessories are not covered by warranty service).

•Only the original owner of bikes purchased from Shengmilo's online store is covered by this Limited Warranty.

The Warranty Period begins upon your receipt of the bikes and shall end immediately upon the earlier of the end of the Warranty Period or any sale or transfer of the bike to another person, and under no circumstances shall the Limited Warranty apply to any subsequent owner or other transfers of the bike.

•You must have the initial owner's name & the initial order number to start a warranty claim.

•The Covered Components are warranted to be free of defects in materials and/or workmanship during the Warranty Period.

WARRANTY WILL COVER

Shengmilo will replace any component that is deemed to be defective or damaged

(including damage incurred during shipment) without user error. The warranty covers the listed products and follows the terms below:

Frame

• Shengmilo' frames are covered by a replacement warranty for 12 months.

• This warranty includes a replacement frame only. Labor charges to changeover parts to replacement frames are not included.

• Shengmilo reserves the right to use scratch and dent stock when replacing a frame under this warranty. Frame styles and/or colors not in stock may be replaced with a compatible style and/or color at the discretion of Shengmilo.

Batteries

• Shengmilo' batteries are covered by a 6-month prorated warranty.

• Defective batteries will send accessories to customers for free for self-repair during the 6-month service period.

The warranty period for repaired batteries is based on the original purchase date.

• After the first 6 months of service — A prorated credit, based on months of service, will be applied toward the purchase of a new battery. Batteries purchased at pro-rated cost will have a new 6 months warranty based on the pro-rated purchase date.

• No cash reimbursement will be made.

• Batteries can be assessed and found defective directly by Shengmilo only.

Parts & Components

•ALL Original Shengmilo bike's parts & components are covered by the warranty.

PRECAUTIONS AND MAINTENANCE

PARK:6 LIMITED WARRANTY**This Limited Warranty Does Not Cover:**

- Normal wear and tear of any Covered Component.
- Labor charges to changeover parts to replacement frames are not included.
- Consumables or normal wear and tear parts (including without limitation tires, tubes, brake pads, cables, housing, grips, chain, and spokes).
- Any damage or defects to Covered Components resulting from failure to follow instructions in the e-bike owner's manual, acts of God, accident, misuse, neglect, abuse, commercial use, alterations, modification, improper assembly, installation of parts or accessories not originally intended or compatible with the bike as sold, operator error, water damage, extreme riding, stunt riding, or improper follow-up maintenance.
- For the avoidance of doubt, Shengmilo will not be liable and/or responsible for any damage, failure, or loss caused by any unauthorized service or use of unauthorized parts.
- The Battery is not warranted from damage resulting from power surges, use of an improper charger, improper maintenance, or another such as misuse, normal wear, or water damage.
- Any products sold by Shengmilo that are not an e-bike.

Link to Assembly Video and Online Resources Assembly Video

Please refer to the "COMMUNITY Video" at the Shengmilo website

www.shengmilo-bikes.com/pages/videos to view the official Shengmilo S900 Assembly Video.

Online Resources

For more information on best practices, please visit the Shengmilo official website

www.shengmilo-bikes.com or contact Shengmilo Product

Support with any questions.



We are here to help!

If you have questions, please:

Access Shengmilo's official website WWW.SHENGMILLO-BIKES.COM

Contact us directly by email at INFO@SHENGMILLO-BIKES.COM